

# PATROL<sup>1</sup> - 101

« »

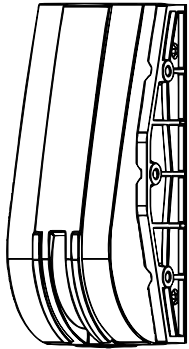

**GSN** Electronic Company Ltd.

1

## PATROL-101

- 55°

## PATROL-101

## PATROL-101

## PATROL-101

30

2

+  
%QUAD+

30

(1-7)

3

1.

2.

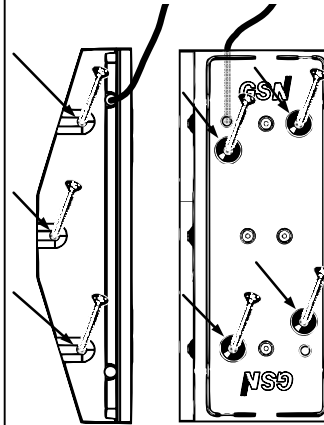

4

3.

4.

5.

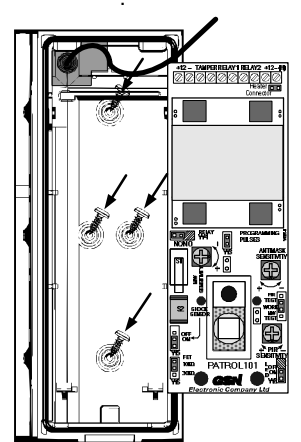

5

6.

+12V- TAMPER RELAY1 RELAY2 +12V-(H)

+12V-

TAMPER

24-

RELAY 1

PIR

RELAY 2

+12V- (H)

12-16 /1

!

6

( . ) .

2.5

3.5

-20°

!

!

2.5

М

Е

Т

Р

А

↓

15

МЕТРОВ

7

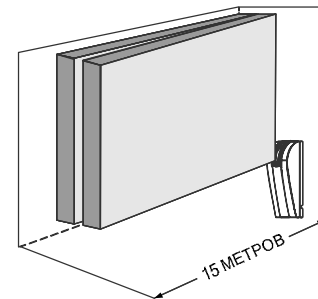
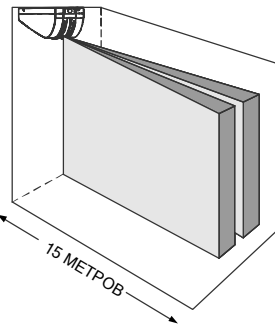

8

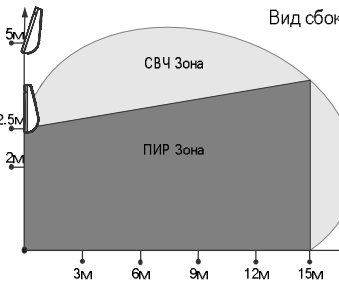
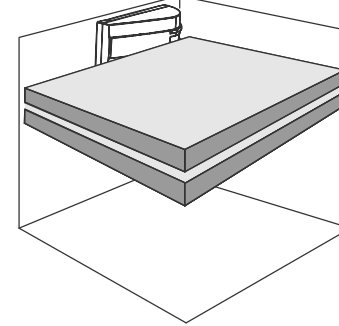

9

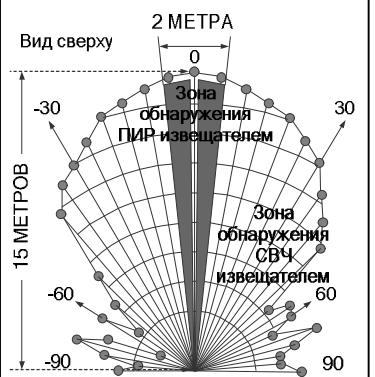

10

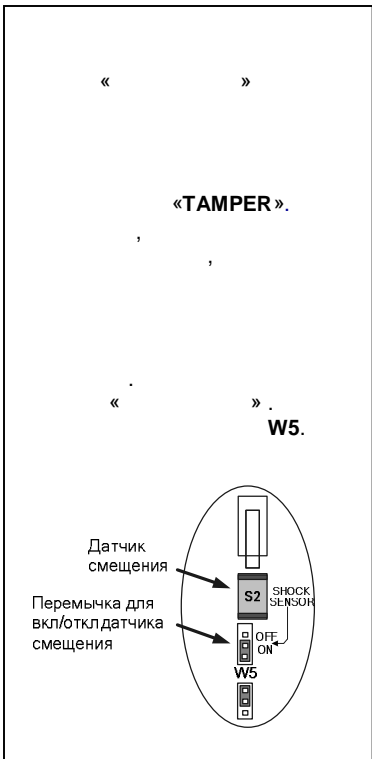

11

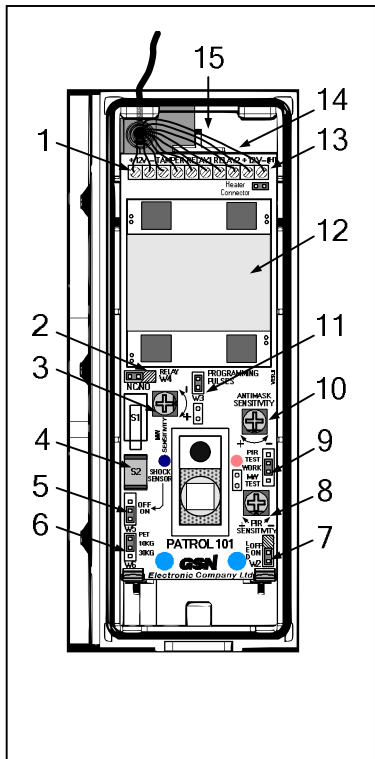

12

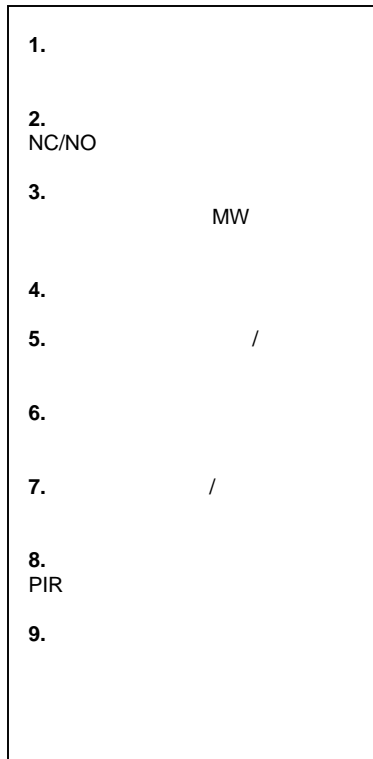

13

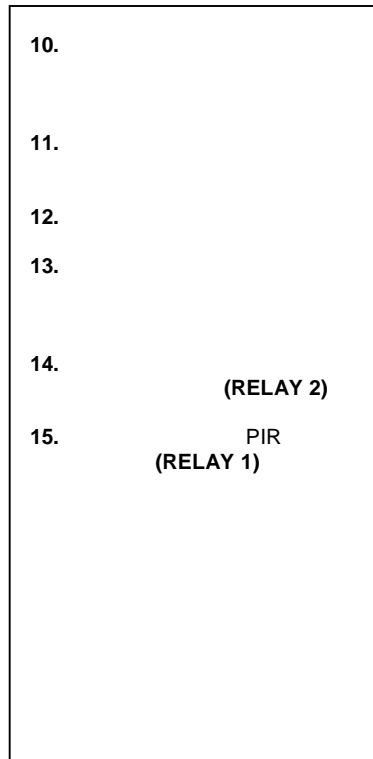

14

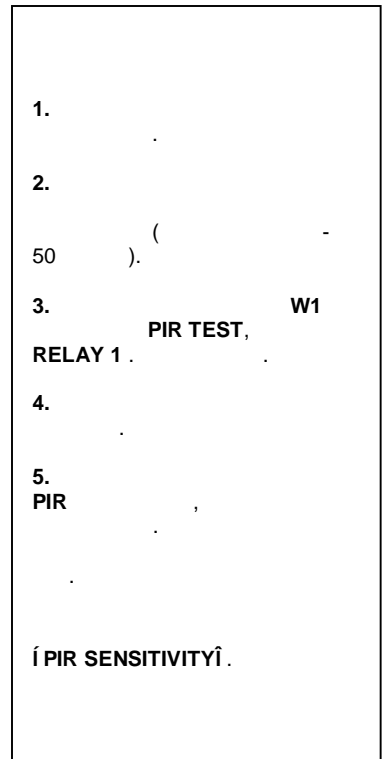

15

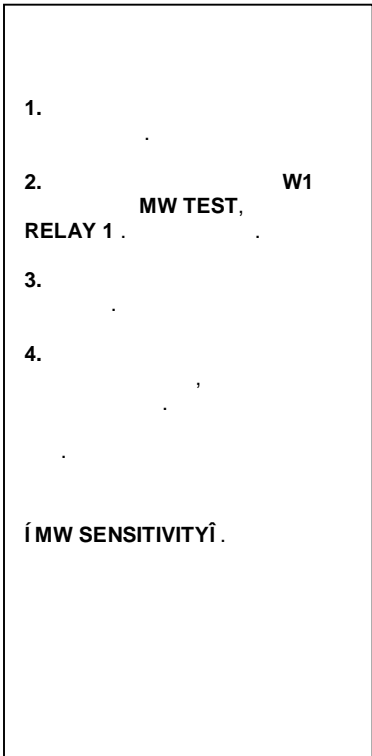

16

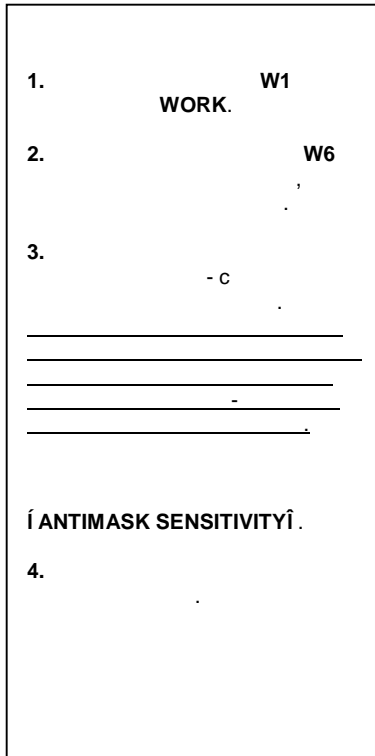

17

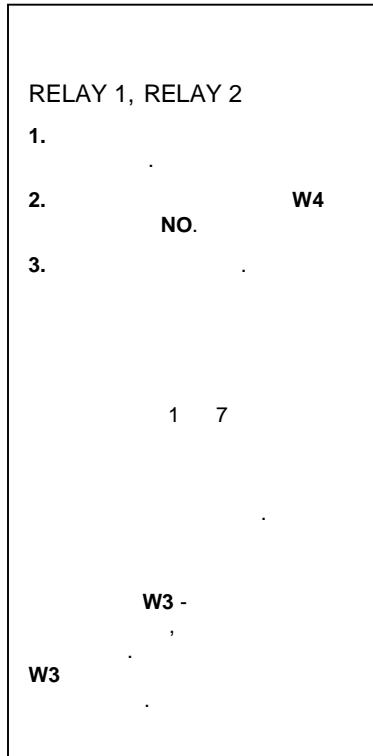

18

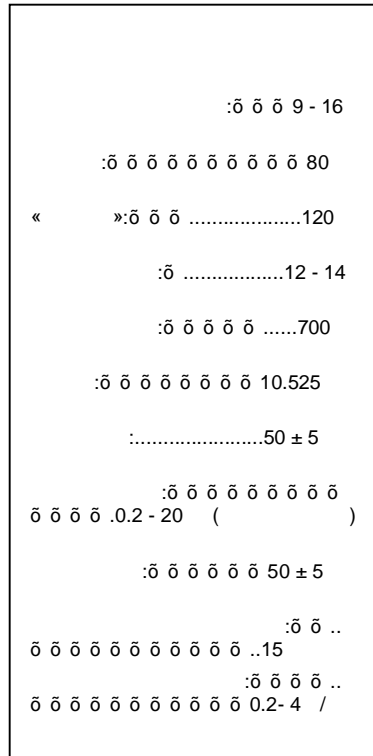

19

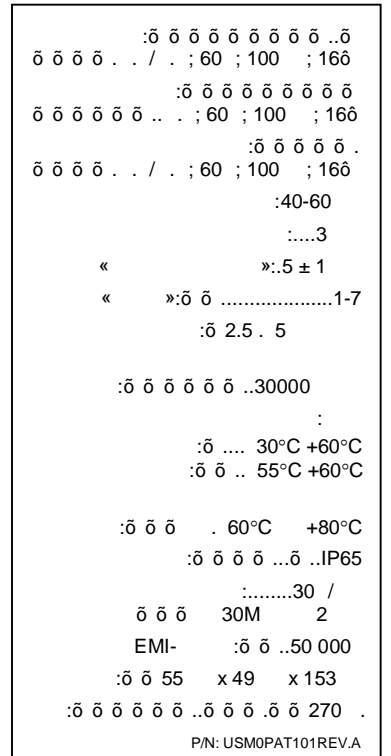

20