

#### EN - CE DECLARATION OF CONFORMITY

**Note:** The text herein has been adapted to meet editorial requirements. A copy of the original declaration may be requested from Nice S.p.a. (TV) I.

Declaration number: **512/AGIO**; rev.: **1**; Language: **EN**

The undersigned Roberto Griffa, in the role of Chief Executive Officer of NICE S.p.A. (via Pezza Alta no. 13, 31046 Rustignè di Oderzo (TV), Italy), declares under his sole responsibility that the products AG4BB, AG4BW, AG4BR, AG4B, AG4W, AG4R (and accessories AGBASEB, AGBASEW, AGBASER), conform to the essential requirements stated in the European directive 1999/5/CE, for the intended use of products. In accordance with the same directive (appendix V), the product is class 1 and marked **CE0682**.

 Mr. Roberto Griffa  
(Chief Executive Officer)

#### FR - DÉCLARATION CE DE CONFORMITÉ

**Note:** Le présent texte a été réadapté pour raisons d'édition. Une copie de la déclaration originale peut être demandée à Nice S.p.a. (TV) - Italie.

Numéro de déclaration : **512/AGIO** ; rév. : **1** ; Langue : **FR**

Le soussigné Roberto Griffa, en qualité de Chief Executive Officer de Nice SpA (Via Pezza Alta n° 13, 31046 Rustignè Oderzo (TV) Italie), déclare sous sa seule responsabilité que les produits AG4BB, AG4BW, AG4BR, AG4B, AG4W, AG4R (et les accessoires AGBASEB, AGBASEW, AGBASER), sont conformes aux exigences essentielles de la directive européenne 1999/ 5/CE, pour l'utilisation à laquelle ses appareils sont destinés. Conformément à la Directive (Annexe V), le produit appartient à la classe 1 et est marqué : **CE0682**.

 Ing. Roberto Griffa  
(Chief Executive Officer)

#### IT - DICHIARAZIONE CE DI CONFORMITÀ

**Nota:** Il testo qui presente è stato riadattato per motivi editoriali. Copia della dichiarazione originale può essere richiesta a Nice S.p.a. (TV) I.

Numero dichiarazione: **512/AGIO**; rev.: **1**; Lingua: **IT**

Il sottoscritto Roberto Griffa, in qualità di Amministratore Delegato della NICE S.p.A. (via Pezza Alta n°13, 31046 Rustignè di Oderzo (TV) Italy), dichiara sotto la propria responsabilità che i prodotti AG4BB, AG4BW, AG4BR, AG4B, AG4W, AG4R (e gli accessori AGBASEB, AGBASEW, AGBASER), risultano conformi ai requisiti essenziali richiesti dalla direttiva comunitaria 1999/5/CE, per l'uso cui gli apparecchi sono destinati. In accordo alla stessa direttiva (allegato V), il prodotto risulta di classe 1 e marcato **CE0682**.

 Ing. Roberto Griffa  
(Amministratore Delegato)

#### DE - CE-KONFORMITÄTSERKLÄRUNG

**Hinweis:** Der hier aufgeführte Text wurde aus Verlagsgründen angepasst. Eine Kopie der ursprünglichen Erklärung kann bei Nice S.p.a. (TV) Italy angefordert werden.

Nummer der Erklärung: **512/AGIO**; rev.: **1**; Sprache: **DE**

Der Unterzeichnende, Roberto Griffa, im Amte des Chief Executive Officer des Unternehmens NICE S.p.A. (Via Pezza Alta 13, 31046 Rustignè di Oderzo (TV) Italy), erklärt unter seiner Verantwortung, dass die Produkte AG4BB, AG4BW, AG4BR, AG4B, AG4W, AG4R (und Zubehör AGBASEB, AGBASEW, AGBASER), den grundsätzlichen Anforderungen der europäischen Richtlinie 1999/5/ EG für die jeweiligen Anwendungszwecke entsprechen. In Übereinstimmung mit dieser Richtlinie (Anlage V), entspricht das Produkt der Klasse 1 und ist **CE0682** gekennzeichnet.

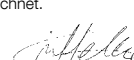
 Ing. Roberto Griffa  
(Chief Executive Officer)

# AGIO

## Transmitter

CE0682



Quick guide

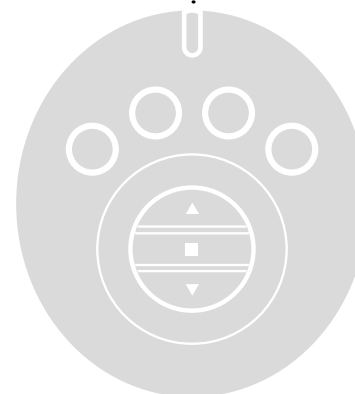

Nice

Nice S.p.A.  
Via Pezza Alta, 13  
31046 Oderzo TV Italy  
info@niceforyou.com

www.niceforyou.com

IS0348B00MM\_14-09-2016

Nice

# AGIO

To manage lights,  
electrical loads and automations

For further information on the Agio system  
and Nice connected devices:

[www.niceforyou.com](http://www.niceforyou.com)

*Per la gestione di lampade,  
carichi elettrici e automazioni*

*Per ogni informazione sul sistema Agio  
e sui dispositivi Nice collegabili:*

[www.niceforyou.com](http://www.niceforyou.com)

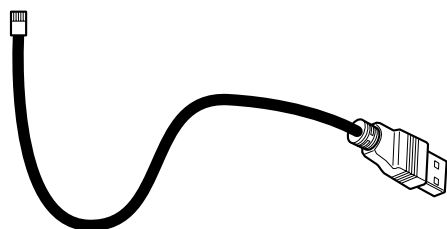
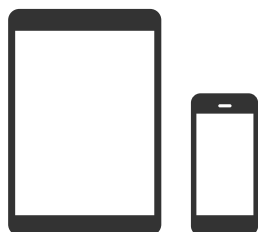

**USB\* jack**  
5 Vdc MAX - 850 mA

**Presca USB\***  
5 Vdc MAX - 850 mA

**LED**  
(flashes during a drive:  
low batteries)  
*(se lampeggia durante  
un azionamento:  
pile scariche)*

**Select**  
connected devices

**Selezione**  
dispositivi collegati

▲ **Dimmer + OPEN** automation  
**Dimmer + APRI** automazione

■ **OFF - ON** (store the last used)  
**STOP** automation  
**OFF - ON** (memorizza l'ultimo  
valore utilizzato)  
**STOP** automazione

▼ **Dimmer - CLOSE** automation  
**Dimmer - CHIUDI** automazione

**Slider** to change, in a continuous  
way or with a touch, the light intensity  
or the position of the automation

**Slider** per variare, in modo continuo  
o con un tocco, l'intensità della luce  
o la posizione dell'automazione

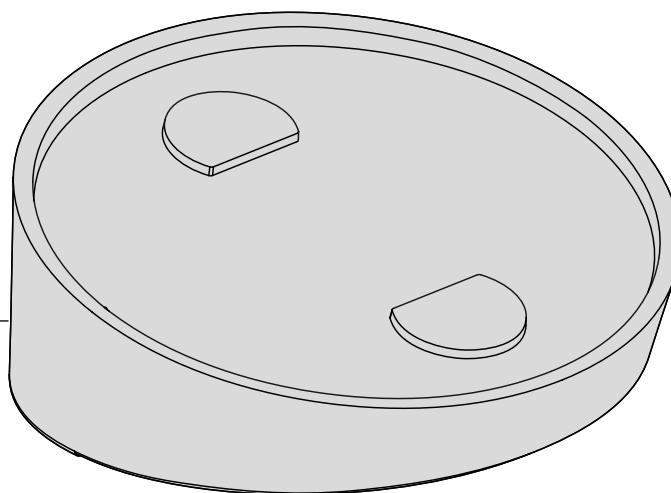
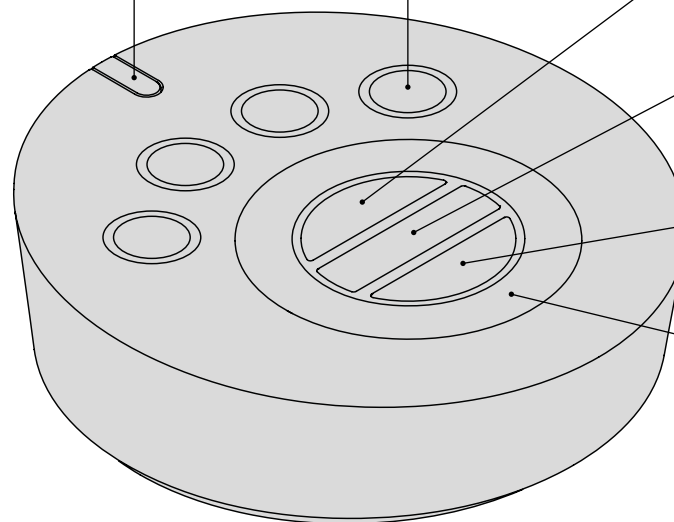
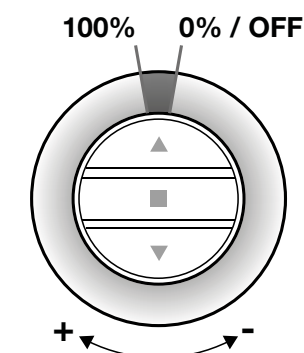

**On/off courtesy light\***  
**On/Off luce di cortesia\***

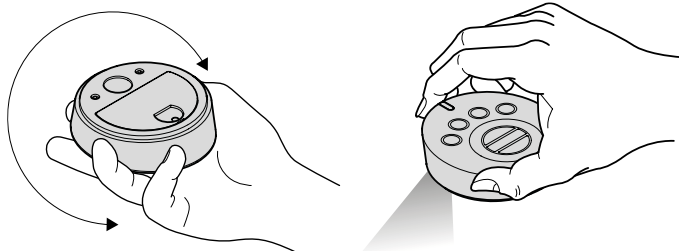

**Wake from standby\***  
**Riattivazione da standby\***

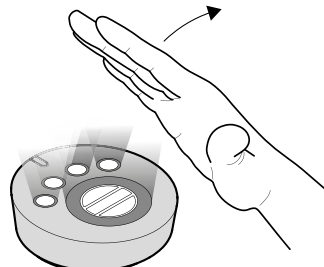

**Wall-mounted\***  
**Fissaggio a parete\***

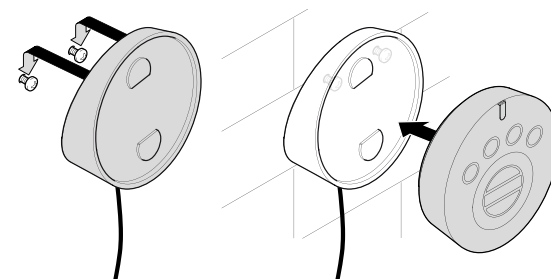

\* AG4B, AG4R, AG4W