

# DCT6

## Wireless Door Contact V1.0

### Installation Manual



### Open/Close

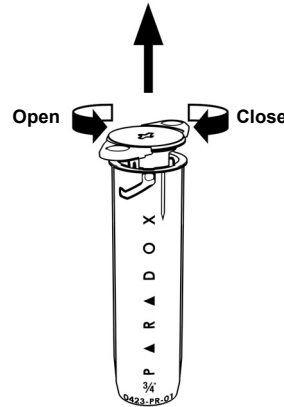

FIGURE 2

### Breaking the Flange

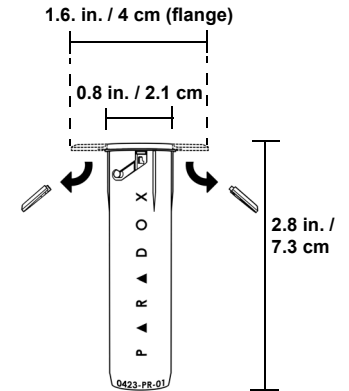

FIGURE 3

## Introduction

The DCT6 is a wireless magnetic door contact that is discreetly hidden within the frame of a door or window.

## Installation

**Transmitter:** Drill a 3/4 in. x 2.75 in. depth (16 mm x 70 mm depth) hole in the frame and insert the DCT6 transmitter. Secure the transmitter body A- with two screws or B- with one screw and remove one flange if it interferes with the radial opening or C- press fit installation on narrow frames, see Figure 3, A, B and C.

**Magnet:** Drill a 3/4 in. x 1.1 in. (19 mm x 28 mm) hole in the frame to be aligned with the transmitter when door/window is closed and insert the magnet with press fit. Make sure it is aligned with the transmitter and that the gap, when closed, is not greater than 0.4 in. / 10 mm.

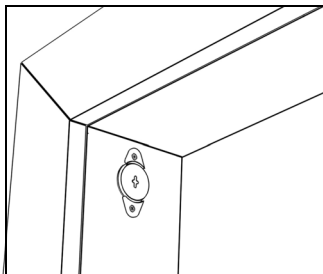

A - Two Screws

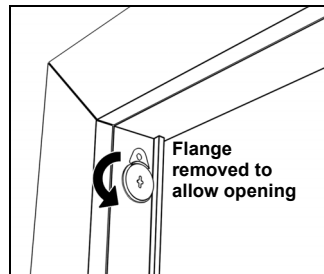

B - One Screw / One Flange

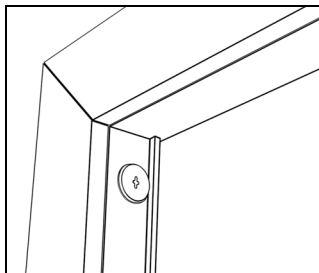

C - Press Fit

## Setting RF Frequency / Replacing Battery

1. Open the top of the DCT6 transmitter, turning the cover counter clockwise, see Figure 2.
2. Locate the switch on the PCB, as shown in Figure 4.
3. Slide the switch to the desired frequency 433 MHz or 868 MHz.
4. Remove the battery for a few seconds. Replace the battery back (verify the polarity and insert properly + and - marked on the battery terminals, see Figure 5).

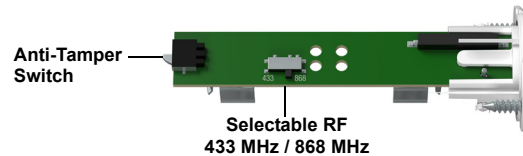

FIGURE 4

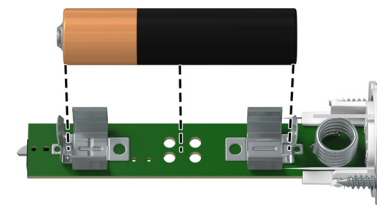

FIGURE 5

We recommend to replace the battery ever 3 years to avoid leakage.

## EVO Programming and Testing

1. Enter section **[4003]**
2. Enter RTX3 or K641LX serial number.
3. Enter section **[101]** to **[132]** to assign the DCT6.
4. Open the transmitter as per Figure 2 then close it. This will register the DCT6 entered section.
5. Test signal strength by entering section **[601]** to **[632]**.
6. Open the transmitter as per Figure 2 then close it.
7. Verify the signal strength on your LCD keypad or TM70/TM50.

## MGSP Programming and Testing

1. Enter available section to assign the DCT6 **[061]** - **[092]**.
2. Open the transmitter as per Figure 2, then close it. This will register the DCT6 to the entered section.
3. Test signal strength by entering correspondent section **[101]** to **[132]**.
4. Open the transmitter as per Figure 2 then close it.
5. Verify the signal strength on your LCD keypad, TM70/TM50.

## Technical Specifications

<b>Power</b>	1 x AAA alkaline battery
<b>RF Frequency</b>	Selectable 433/868 MHz on-board
<b>Battery Life</b>	3 years (replace to avoid leakage) Based on 10 openings/closing a day
<b>Wireless Range</b>	MG5000/MG5050/RTX3 - 40m (130 ft) MG6250 - 20m (65 ft) Wireless range is based on typical indoor installation
<b>Operating Temperature</b>	-20°C to 50°C (-4°F to 122°F)
<b>Anti-tamper Switch</b>	Cover opening
<b>Magnet distance</b>	Up to 0.4 in. / 10 mm
<b>Dimensions</b>	7.3 x 2.1 x 2.1 cm (2.8 x 0.8 x 0.8 in.)
<b>Anti-Tamper Switch</b>	Cover opening
<b>Approvals</b>	CE, EN 50131 Grade 2
<b>Remarks</b>	In-frame installation
<b>Supervision</b>	Live supervision, Battery low
<b>Compatibility</b>	Magellan Panels, MG6250, K32LX, K641LX, RTX3, RX1

### Warranty

For complete warranty information on this product, please refer to the Limited Warranty Statement is found on the website: [www.paradox.com/terms](http://www.paradox.com/terms) or contact your local distributor. Specifications may change without prior notice.

### Patents

US, Canadian and international patents may apply. Paradox is a trademark or registered trademark of Paradox Security Systems (Bahamas) Ltd.