

COMPACT ARRAY SPEAKER SYSTEM

HX-5B/HX-5B-WP

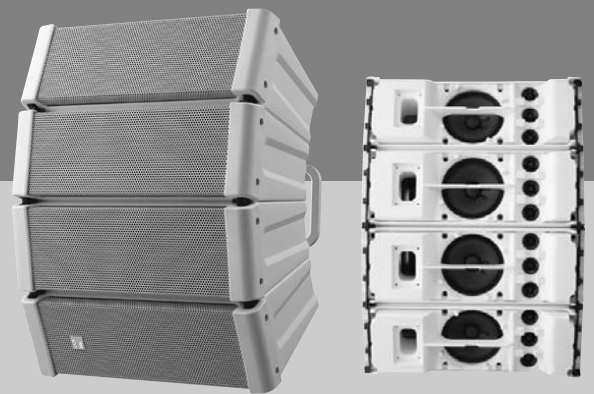

HX-5W/HX-5W-WP



FB-120B/FB-120W



DESCRIPTION

An innovative modular speaker design that offers remarkable versatility for use in public address systems of different venues, the HX-5 Series offers high quality audio reinforcement even in venues with acoustic difficulties. The design effectively combines the advantages of large, traditional horn-loaded tweeter and woofer enclosures and full-range compact speaker boxes without the drawbacks usually experienced with such speakers. These included installation requirements and minimal visual appeal in venues where appearance is important.

FEATURES

- The HX-5 Series offers controllable coverage characteristics. This allows optimal multiple unit configurations for installations in a wide range of venues including auditoriums, places of worship, banquet halls, community centers, sports bars, shopping malls, boardrooms, gyms and many other medium-sized environments.
- The HX-5 Series makes it simple to optimize dispersion for the different acoustic requirements of various venues with a variable dispersion angle that can be set for 60, 45, 30 and 15 degrees.
- Modular HX-5 speakers can be combined to create a better variable dispersion-controlled frequency range with enhanced low frequency output.
- Regardless of mounting on a wall or ceiling, HX-5 speakers exhibit minimal comb filter and interference effects to produce smoother low frequency output.
- Available in black or white finishes to suit venue decoration schemes.
- Subwoofer module for augmenting low frequency response.
- Simple installation requirements include hanging with the accessory brackets using chains, strong wires or cables. There are also other installation options such as a pre-install frame that can include a subwoofer, ceiling and wall brackets, and an adapter for installing on a dedicated stand.

HX-5B/HX-5B-WP/HX-5W/HX-5W-WP

FEATURES

■ Design background

The HX-5 is an innovative modular speaker design that incorporates the best characteristics of the traditional, cumbersome woofer enclosure combined with a CD horn-loaded high frequency driver and the full-range compact speaker enclosure without the drawbacks associated with each type.

The traditional speaker system was able to provide well-controlled sound coverage but posed various difficulties for correct installation and also presented an old-fashioned appearance as well that impacts on the venue's appearance. The full-range compact speaker enclosure is easy to install, but the design's sound coverage is hard to control.

The HX-5 features remarkably easy to control coverage characteristics including problematic low frequencies and can be installed in a multitude of ways while maintaining a modern, unobtrusive appearance.

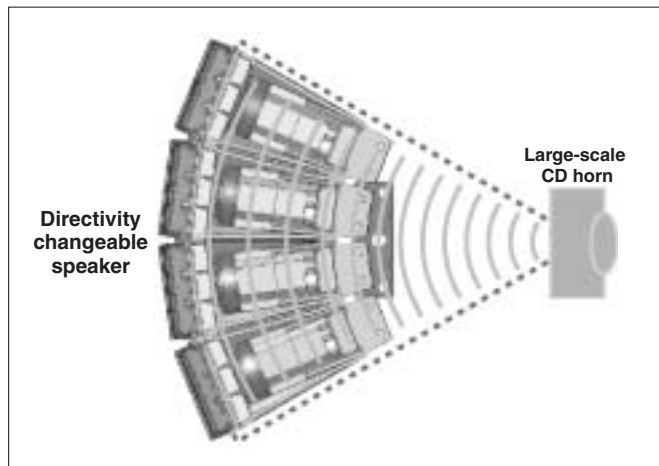

■ Minimal reflective effects

Whether mounted on the wall or ceiling, the HX-5 is remarkably free from the comb filter and interference effects often encountered with other speaker designs. It can therefore produce more low frequency output even when mounted on the wall or ceiling.

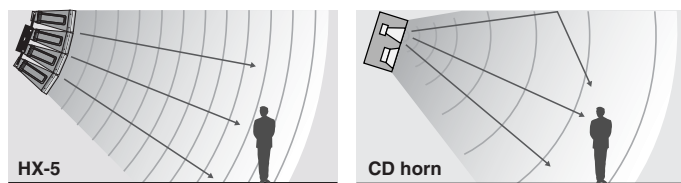

■ Adjustable sound dispersion

A system is configured by vertically stacking four speaker modules with a total driver complement of four woofers and 12 tweeters positioned along the baffle surface. This configuration allows the variable directivity control and low-frequency dispersion control comparable to using a large constant-directivity horn speaker. A choice of four directivity angles — 15, 30, 45 and 60 degrees can be employed as needed. For instance, a specific directivity angle, or each module can have its directivity independently set for a specific coverage requirement. When two or multiple modules are connected to configure an arc, they effectively function as an immense single speaker controlling directivity for considerably lower frequencies. As a result, public address functions demonstrate optimal intelligibility even in environments with long reverb times.

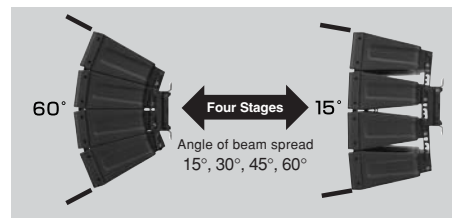

When you arrange the plural

In multiple unit configurations, the HX-5 will be able to deliver greater low frequency output over its angle of dispersion.

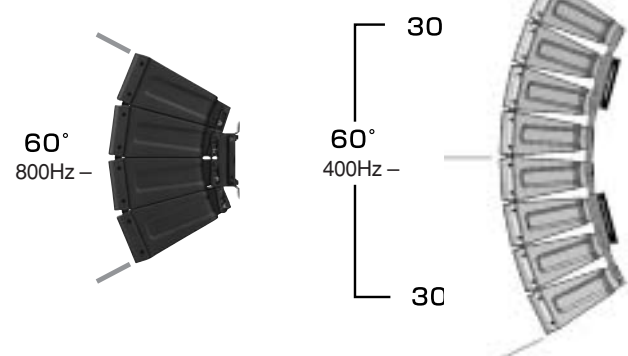

■ Versatile mounting options

Compared to many other speaker designs, the HX-5 Series is remarkably easy to install in several ways. It can be hung easily with chains, strong wires and cables using the accessory brackets. There are also options for hanging with a pre-install frame by itself or configured with a subwoofer. There are also other options including ceiling and wall brackets as well as an adapter for use with a dedicated stand.

HX-5B/HX-5B-WP/HX-5W/HX-5W-WP

FREQUENCY RESPONSE

HX-5B/HX-5W

Single Unit: 8Ω (1W/1m)

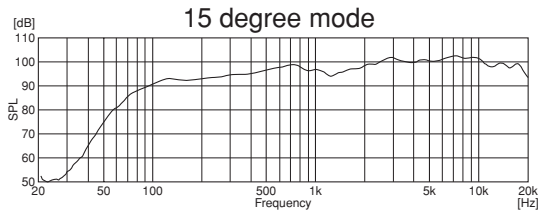
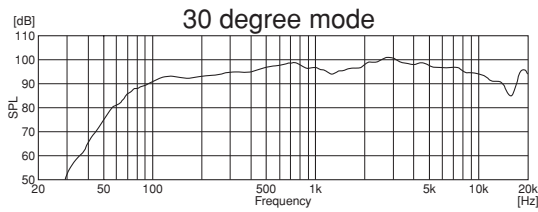
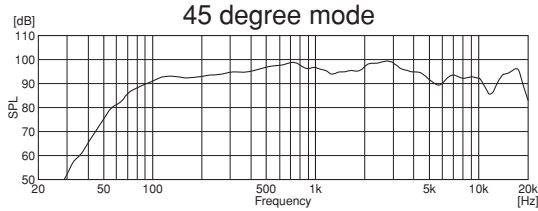
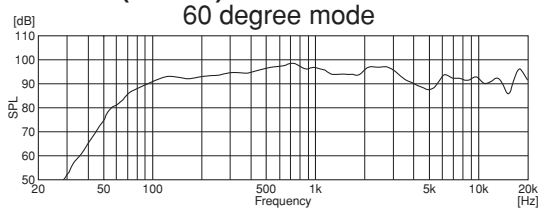

Connected Two Units: 4Ω (1W/1m)

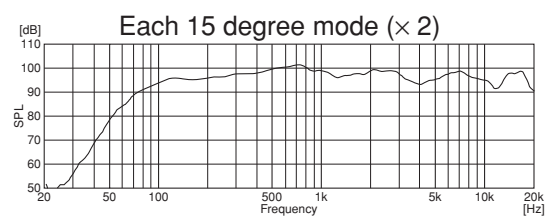
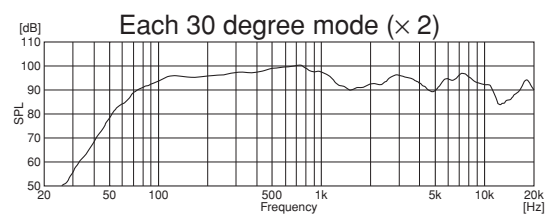
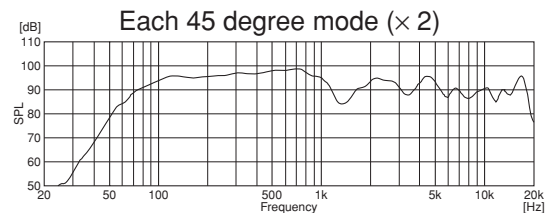
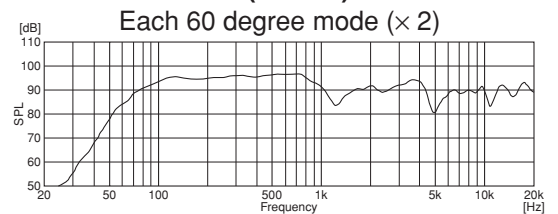

HX-5B-WP/HX-5W-WP

Single Unit: 8Ω (1W/1m)

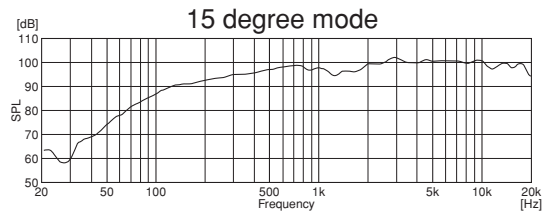
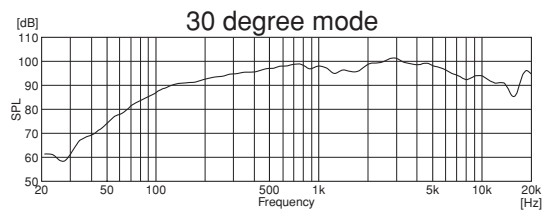
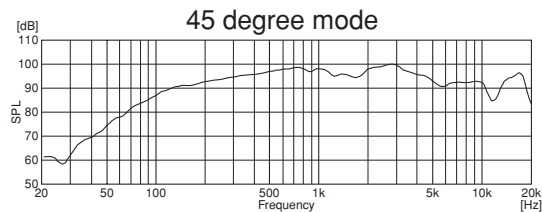
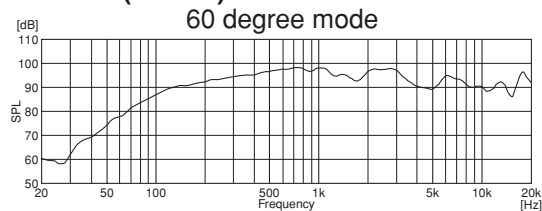

Connected Two Units; 4Ω (1W/1m)

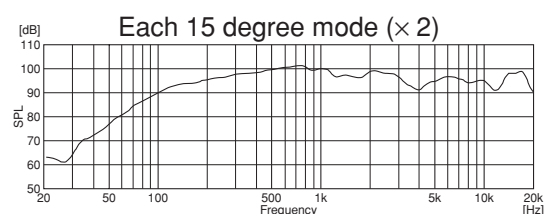
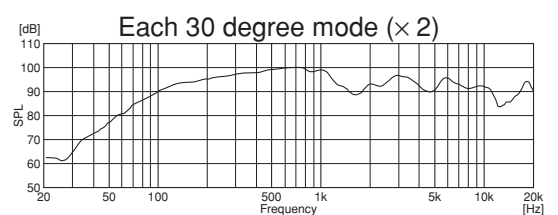
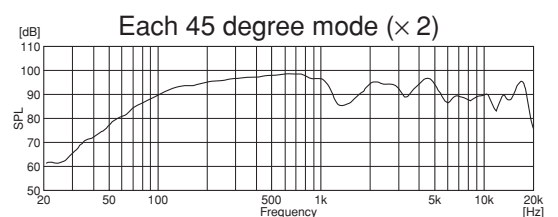
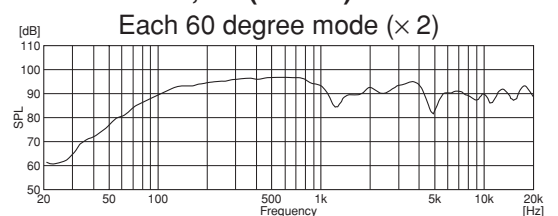

HX-5B/HX-5B-WP/HX-5W/HX-5W-WP

POLAR PATTERN (VERTICAL)

Single Unit

60 degree mode

45 degree mode

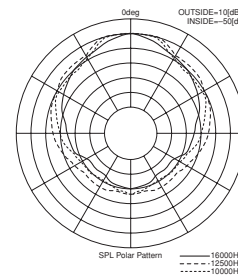
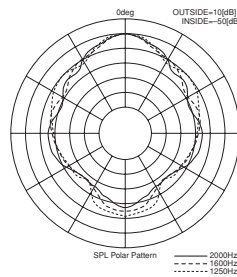
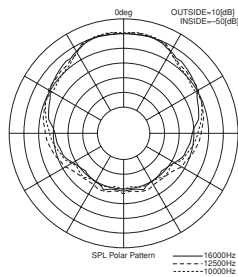
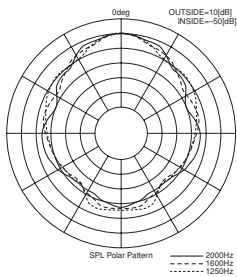
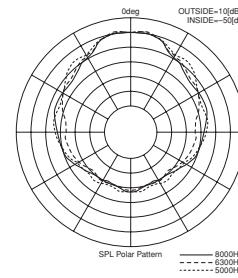
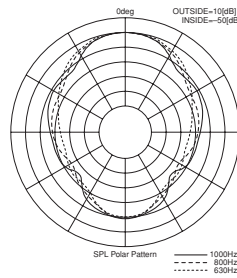
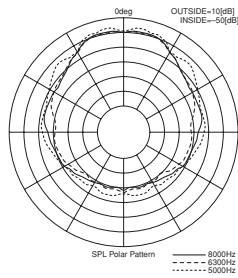
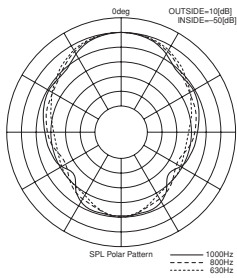
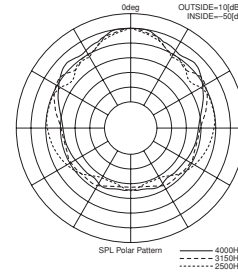
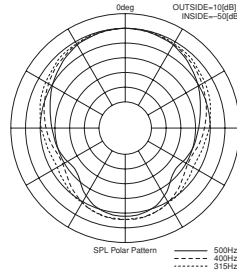
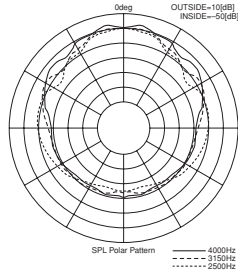
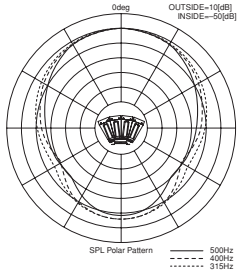

30 degree mode

15 degree mode

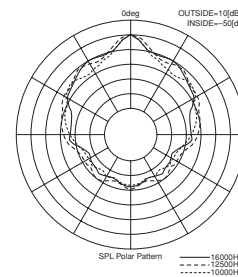
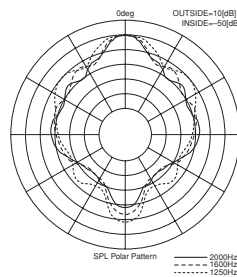
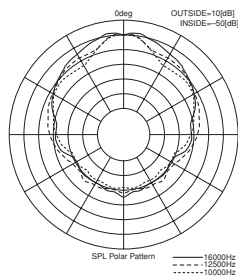
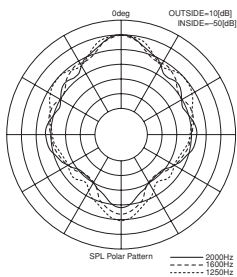
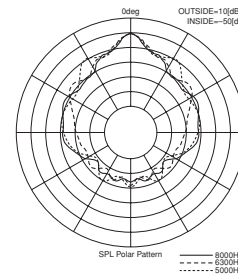
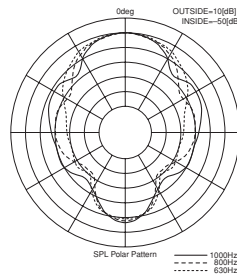
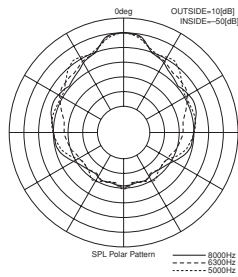
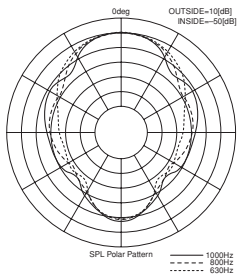
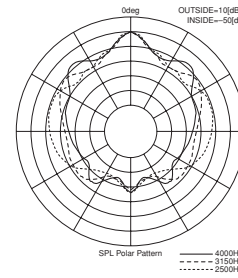
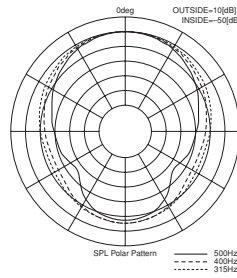
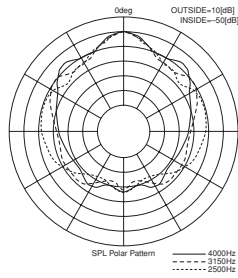
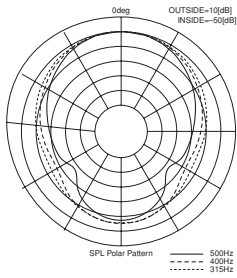

HX-5B/HX-5B-WP/HX-5W/HX-5W-WP(x2)

POLAR PATTERN (VERTICAL)

Connected Two Units

Each 60 degree mode (x 2)

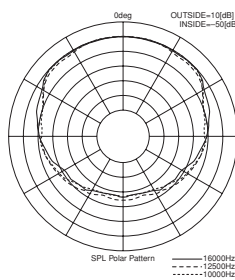
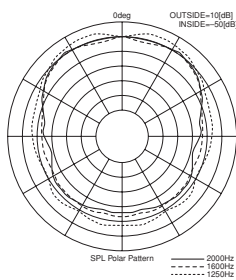
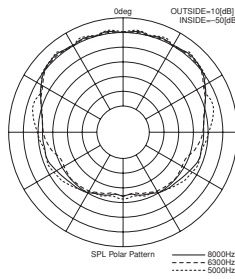
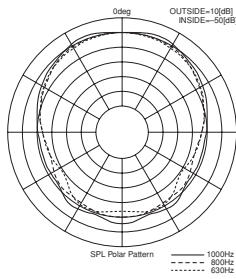
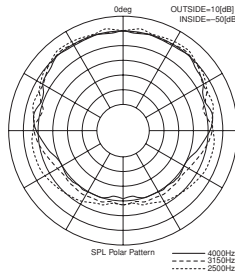
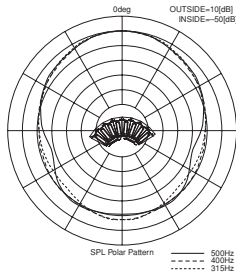

Each 45 degree mode (x 2)

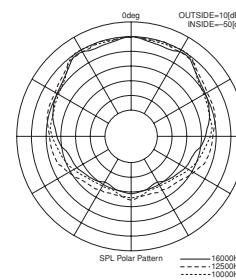
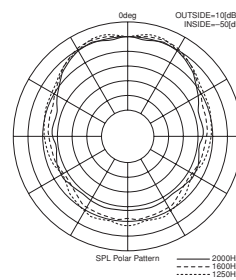
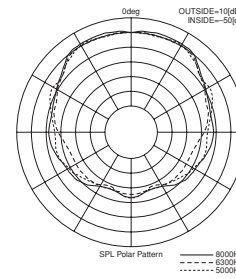
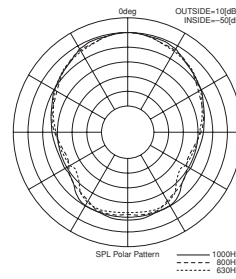
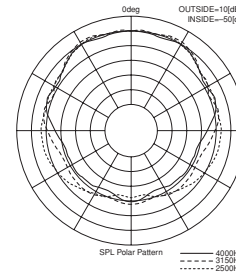
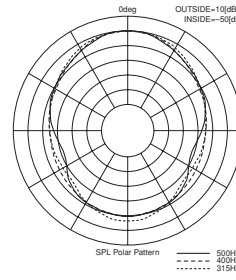

Each 30 degree mode (x 2)

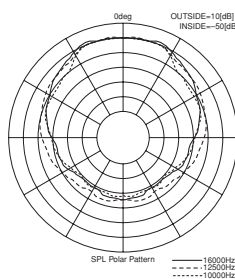
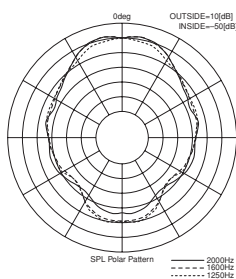
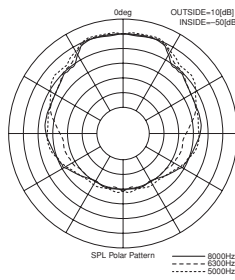
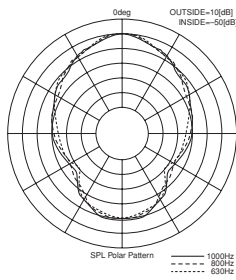
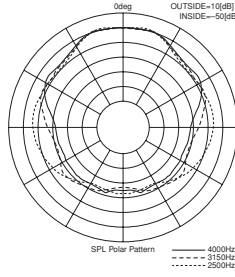
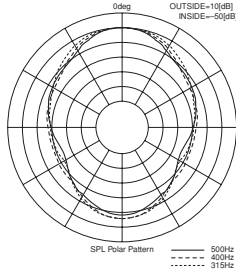

Each 15 degree mode (x 2)

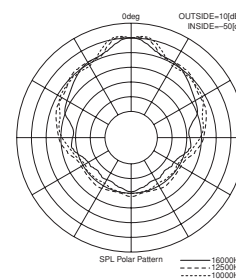
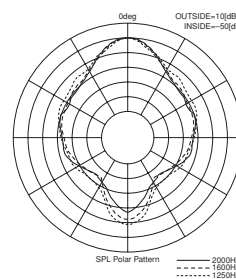
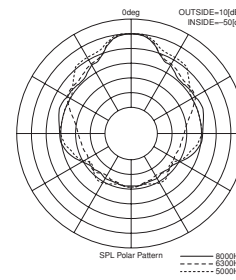
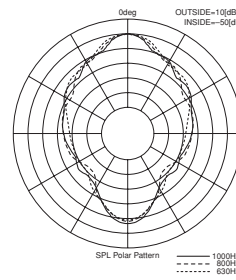
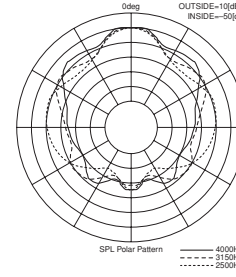
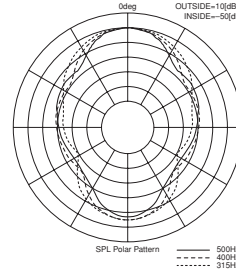

HX-5B/HX-5B-WP/HX-5W/HX-5W-WP

POLAR PATTERN (HORIZONTAL)

Single Unit

60 degree mode

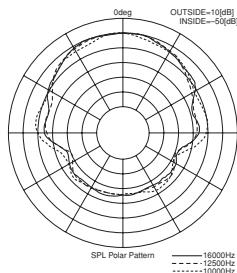
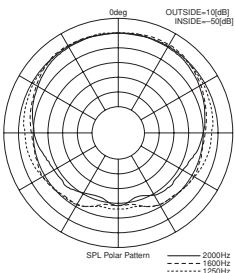
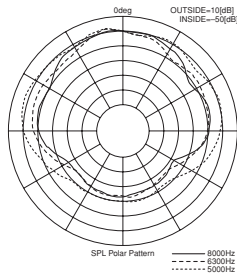
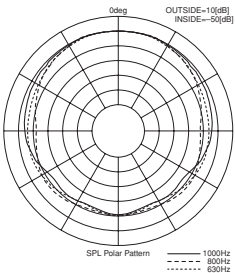
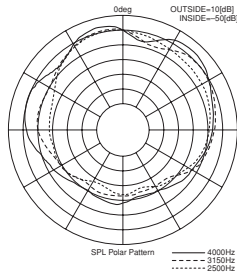
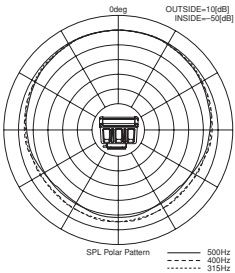

Connected Two Units

Each 60 degree mode (× 2)

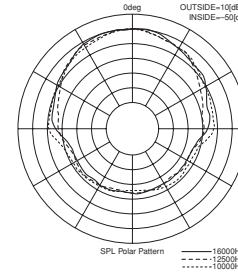
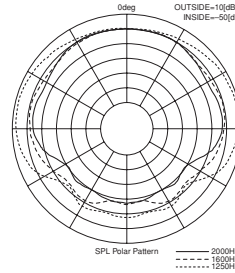
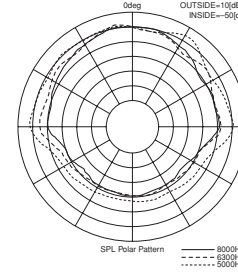
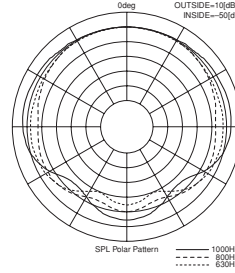
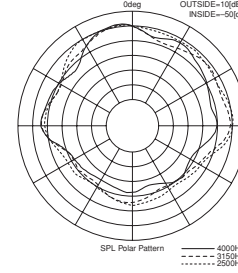
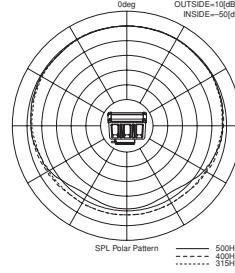

HX-5B/HX-5B-WP/HX-5W/HX-5W-WP

BEAMWIDTH vs FREQUENCY

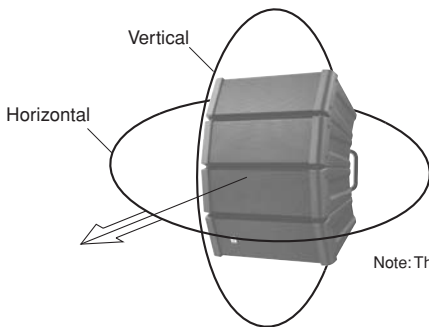

Note: The HX-5 series can be used vertically or horizontally.

Vertical Plans

Single Unit

60 degree mode

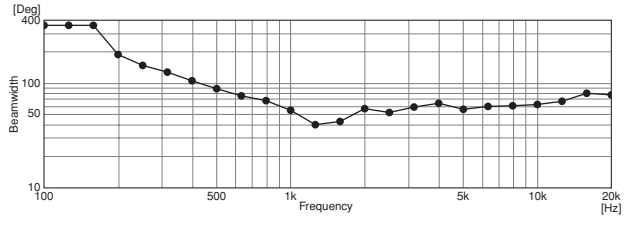

45 degree mode

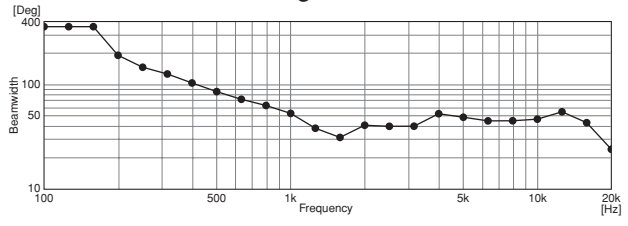

30 degree mode

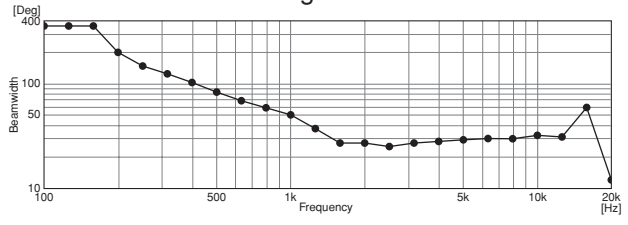

15 degree mode

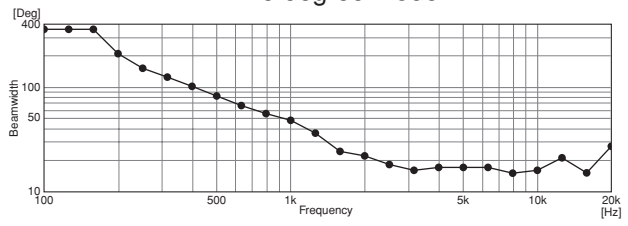

Connected Two Units

Each 60 degree mode (x 2)

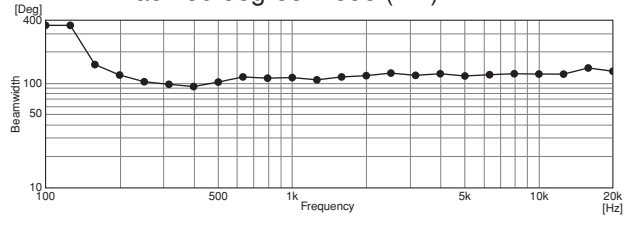

Each 45 degree mode (x 2)

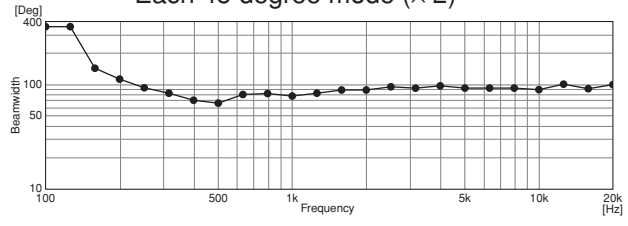

Each 30 degree mode (x 2)

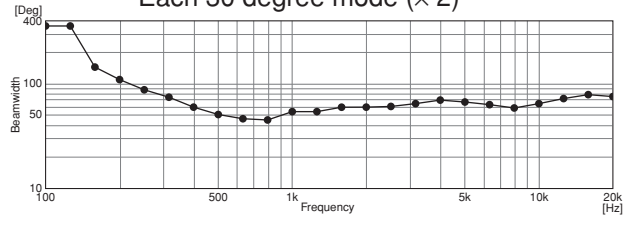

Each 15 degree mode (x 2)

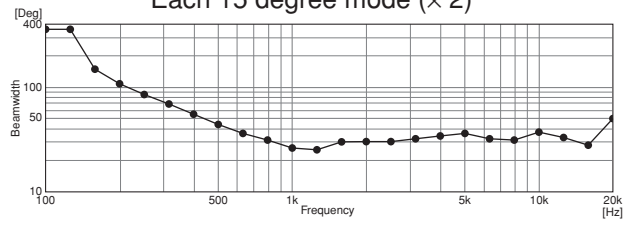

Horizontal Plans

Single Unit

60 degree mode

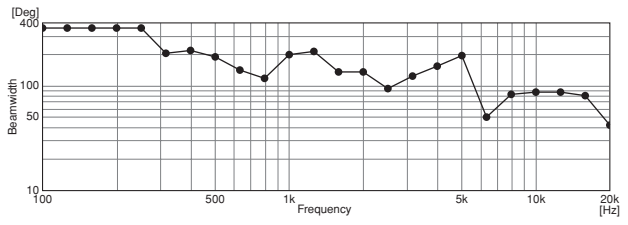

Connected Two Units

Each 60 degree mode (x 2)

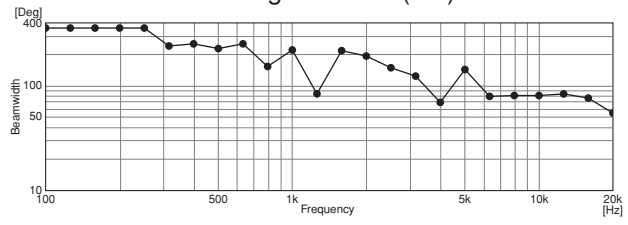

HX-5B/HX-5B-WP/HX-5W/HX-5W-WP

Q vs FREQUENCY

Single Unit

60 degree mode

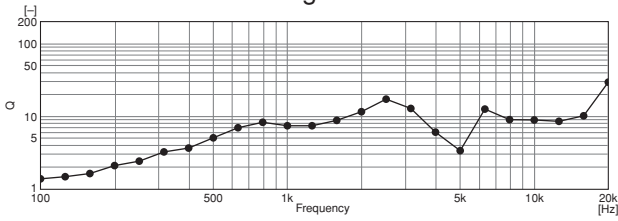

45 degree mode

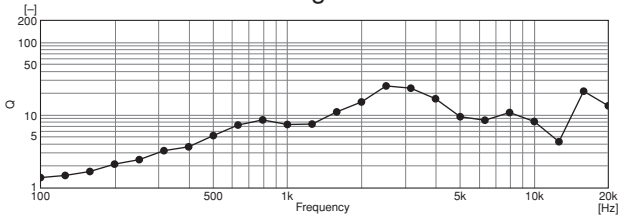

30 degree mode

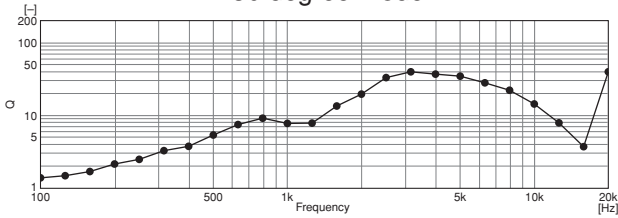

15 degree mode

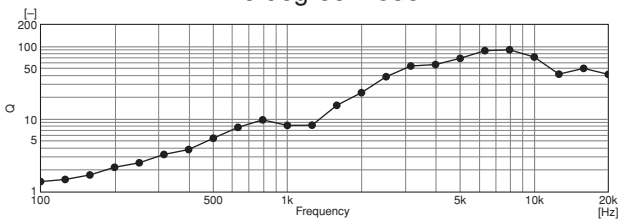

Connected Two Units

Each 60 degree mode (x 2)

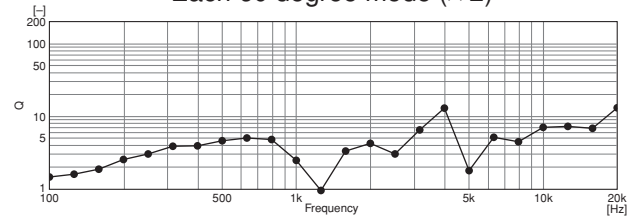

Each 45 degree mode (x 2)

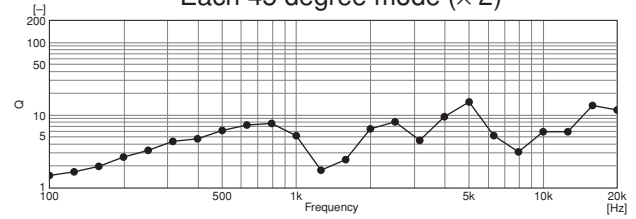

Each 30 degree mode (x 2)

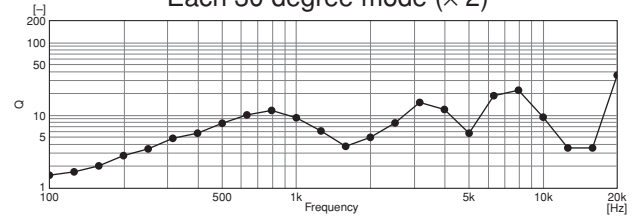

Each 15 degree mode (x 2)

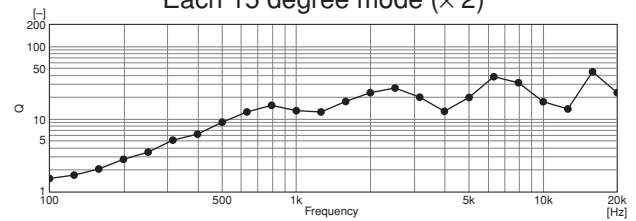

IMPEDANCE vs FREQUENCY RESPONSE

HX-5B/HX5W

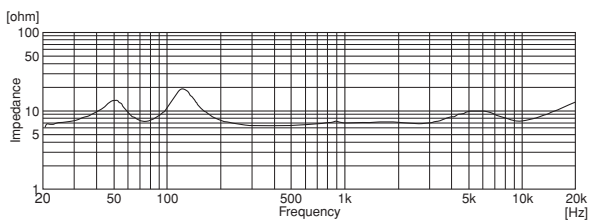

HX-5B-WP/HX5W-WP

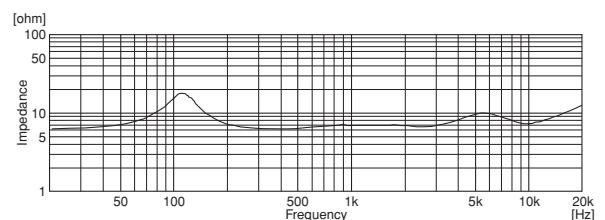

HX-5B/HX-5B-WP/HX-5W/HX-5W-WP/FB-120B/W

EQ RECOMMENDATION

For HX-5B/W/B-WP/W-WP

Filter	Frequency	Gain	Q
HPF (12dB/oct)	60Hz	—	2.053
PEQ	65Hz	+2dB	1.414
PEQ	800Hz	-3dB	0.7
PEQ	2.5kHz	-4dB	2.997
PEQ	5kHz	+5dB	0.305

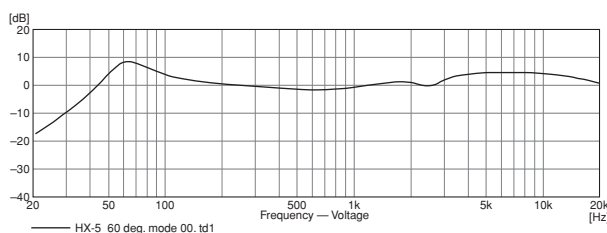

For HX-5B/W/B-WP/W-WP (low cut) and FB-120B/W

For HX-5B/W/B-WP/W-WP

Filter	Frequency	Gain	Q
HPF BW (24dB/oct)	90Hz	—	—
PEQ	800Hz	-3dB	0.7
PEQ	2.5kHz	-4dB	2.997
PEQ	5kHz	+5dB	0.305

For FB-120B/W

Filter	Frequency	Q
HPF (12dB/oct)	40Hz	2.053
LPF BW (24dB/oct)	100Hz	—

Note: When using the processor with HX-5 and FB-120, ensure that the wiring polarity of both units is the same. The level balance shown below is just reference, it should be adjusted.

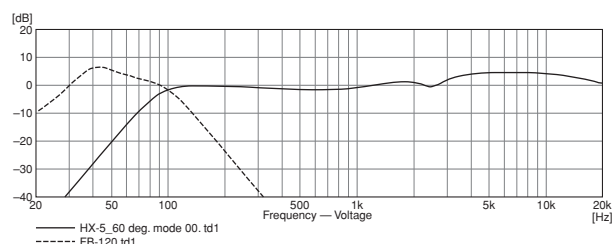

APPEARANCE AND DIMENSIONAL DIAGRAM

HX-5B/HX5W

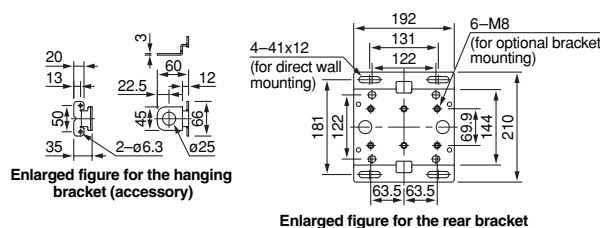
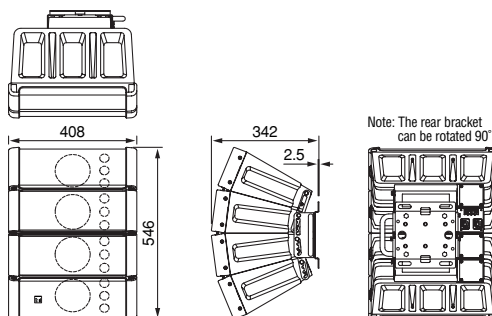

Example for directivity angle modes

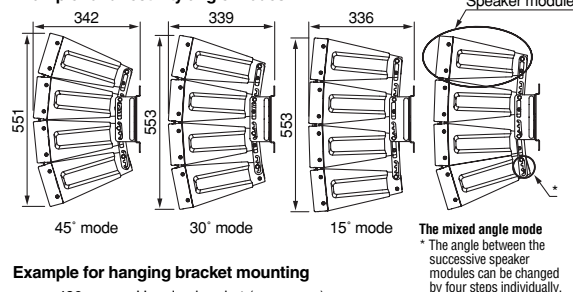

Example for hanging bracket mounting

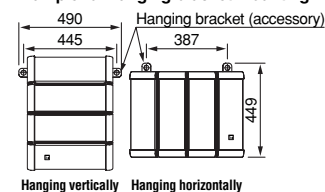

HX-5B-WP/HX5W-WP

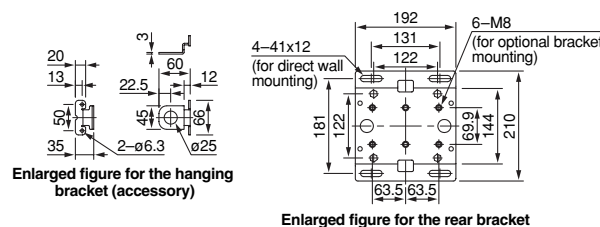
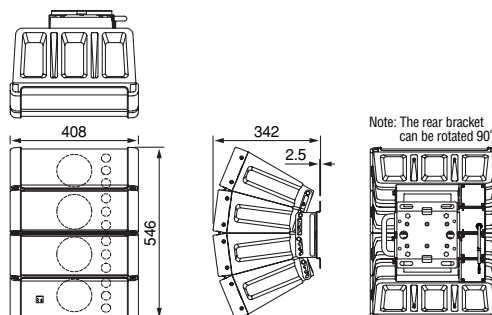

Example for direct wall mounting

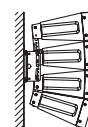

Dimensions for direct wall mounting

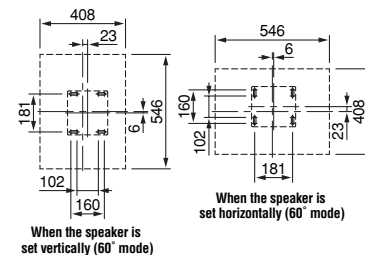

SPECIFICATIONS

	HX-5B	HX-5W	HX-5B-WP	HX-5W-WP
Enclosure	Bass-reflex type		Sealed type	
Power Handling Capacity	Continuous pink noise: 200W, Continuous program: 600W			
Rated Impedance	8Ω			
Sensitivity (1W, 1m)	96dB (60° mode), 97dB (45° mode), 98dB (30° mode), 99dB (15° mode)*			
Frequency Response	70 – 20,000Hz (–10dB) (60° mode), 75 – 20,000Hz (–10dB) (45° mode), 80 – 20,000Hz (–10dB) (30° mode), 85 – 20,000Hz (–10dB) (15° mode)		95 – 20,000Hz (–10dB) (60° mode), 100 – 20,000Hz (–10dB) (45° mode), 105 – 20,000Hz (–10dB) (30° mode), 110 – 20,000Hz (–10dB) (15° mode)	
Crossover Frequency	4kHz			
Directivity Angle	Horizontal: 100° (over 2000Hz) Vertical: 60° (over 800Hz), 45° (over 1.2kHz), 30° (over 1.6kHz), 15° (over 3.2kHz) variable			
Speaker Component	Low frequency: 12cm cone-type × 4 High frequency: Balanced dome-type × 12			
Input Terminal	Speakon NL4MP × 2 and M4 screw terminal		—	
Speaker Cord	—		2-core cable cord with diameter of 6mm	
Water Protection	—		IPX4 (Install with the every speaker module downward)	
Operating Temperature	—		–15°C to +50°C	
Finish	Enclosure: Polypropylene, black	Enclosure: Polypropylene, white	Enclosure: Polypropylene, black	Enclosure: Polypropylene, white
Dimensions	408 (W) × 546 (H) × 342 (D)mm			
Weight	16kg			
Accessory	Hanging bracket × 2, Hex. wrench × 1			
Option	Matching transformer: MT-200 Speaker mounting bracket: HY-PF1B, HY-CW1B, HY-WM1B, HY-WM2B, HY-CN1B Speaker stand adapter: HY-ST1	Matching transformer: MT-200 Speaker mounting bracket: HY-PF1W, HY-CW1W, HY-WM1W, HY-WM2W, HY-CN1W Speaker stand adapter: HY-ST1	Matching transformer: MT-200 Speaker mounting bracket: HY-PF1WP, HY-CW1WP, HY-WM1WP, HY-WM2WP, HY-CN1B-WP	Matching transformer: MT-200 Speaker mounting bracket: HY-PF1WP, HY-CW1WP, HY-WM1WP, HY-WM2WP, HY-CN1W-WP

* (Factory-preset: 60° mode)

	FB-120B	FB-120W	
Power Handling Capacity	Continuous pink noise: 200W, Continuous program: 600W		
Impedance	8Ω		
Sensitivity	90dB (1W, 1m) at installation in free sound field 96dB (1W, 1m) at installation in 1/2 free sound field		
Frequency Response	40 – 1,200Hz (–10dB)		
Speaker Component	30cm cone-type		
Input Terminal	Speakon NL4MP × 2 and M4 screw terminal, distance between barriers: 11mm		
Finish	Enclosure: Wood Punched net: Steel plate, black, paint	Enclosure: Plywood Punched net: Steel plate, white, paint	
Dimensions	408 (W) × 408 (H) × 450 (D)mm		
Weight	15kg		
Option	Speaker rigging frame: HY-PF1B	Speaker rigging frame: HY-PF1W	unit: mm

OPTIONAL ACCESSORIES



**HY-PF1B
HY-PF1W
HY-PF1WP
Rigging Frame**



**HY-WM1B
HY-WM1W
HY-WM1WP
Mounting Bracket**



**HY-ST1
Speaker Stand Adapter**



**HY-CW1B
HY-CW1W
HY-CW1WP
Ceiling Mounting Bracket**



**HY-WM2B
HY-WM2W
HY-WM2WP
Mounting Bracket**



**MT-200
Matching Transformer**



**HY-CN1B
HY-CN1B-WP
HY-CN1W
HY-CN1W-WP
Extension Bracket**